

MaxMotion

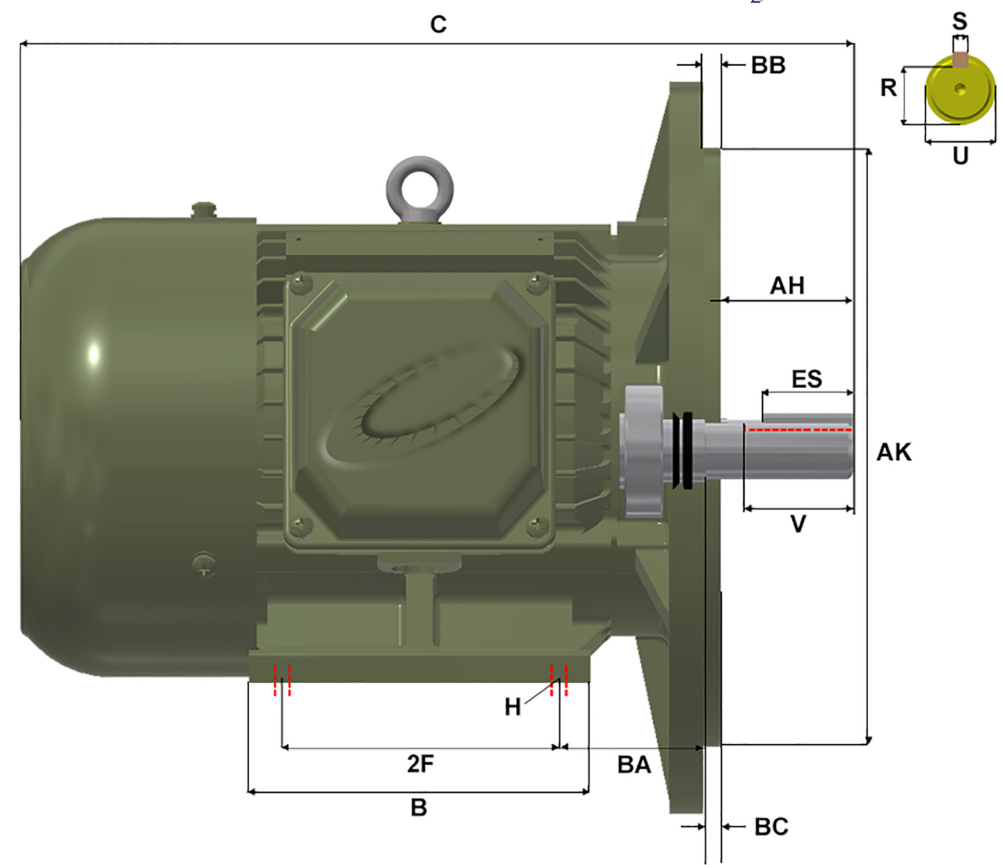
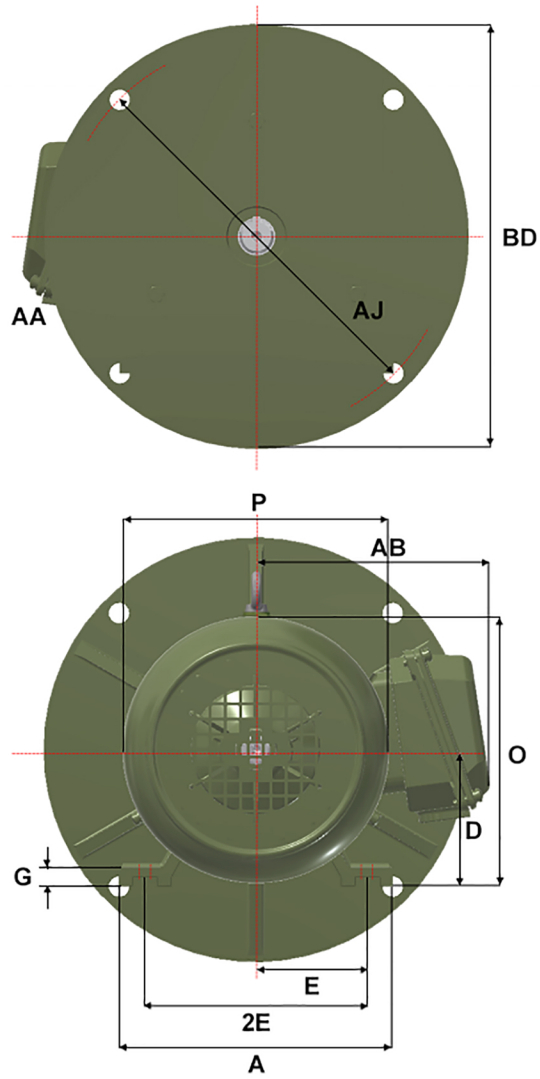

Version: 2WTI		Revised: 08-10-2019		HP	RPM	FRAME	ENCLOSURE	MPP/MQP-14D					
Customer is responsible in determining that MEP product will fit/perform suitably in the intended application				2	900	213TD	TEFC						
A	B	C	D	E	2E	2F	G	H	O	P	R	S	
11.00	7.90	18.90	5.25	4.25	8.50	5.50	0.70	4 * 0.41	10.50	10.2	1.201	0.312	
T	U	V	AA	AB	AH	AJ	AK	BA	BB	BC	BD	ES	
1.90	1.375	3.12	1 NPT	8.30	3.38	10.00	9.00	3.50	0.25	0.00	11.00	2.41	